



## **ActiveLED**® Sports Lighting starts here...

Ballfield, Ice Rink, Stadium, Racquetball, Badminton,  
Tennis, Swimming Pool, Soccer, Gymnasium, Volleyball...

### **Conventional Sports Lighting**

Sports lighting is a long term investment and in the past also had a large consumable part to it, in energy and in light bulbs.

The use of a sports facility had to be managed by turning on the lights well in advance of using the field or arena.

The time the facility could be used had to be limited to 600 hours a year or additional cost was incurred in maintenance and bulb replacement.

Light levels and colors are always changing with the age of the light bulb showing significant lumen depreciation after 100 ON/OFF cycles or 200 hours of running.

### **Only ActiveLED Can Deliver**

If it comes to sports lighting, only ActiveLED can solve these issues, delivering the light output, the durability and the control capabilities.

ActiveLED has no limit on hours of use, significantly less power usage, no bulb replacement. ActiveLED lights can be turned OFF and ON at will.

ActiveLED comes on with full power immediately and can be controlled to use the right amount of light for the activity.

ActiveLED gives a 10 year "no light loss" guaranty. There is no lumen depreciation and even after 10 years we guaranty 90% of original light output.

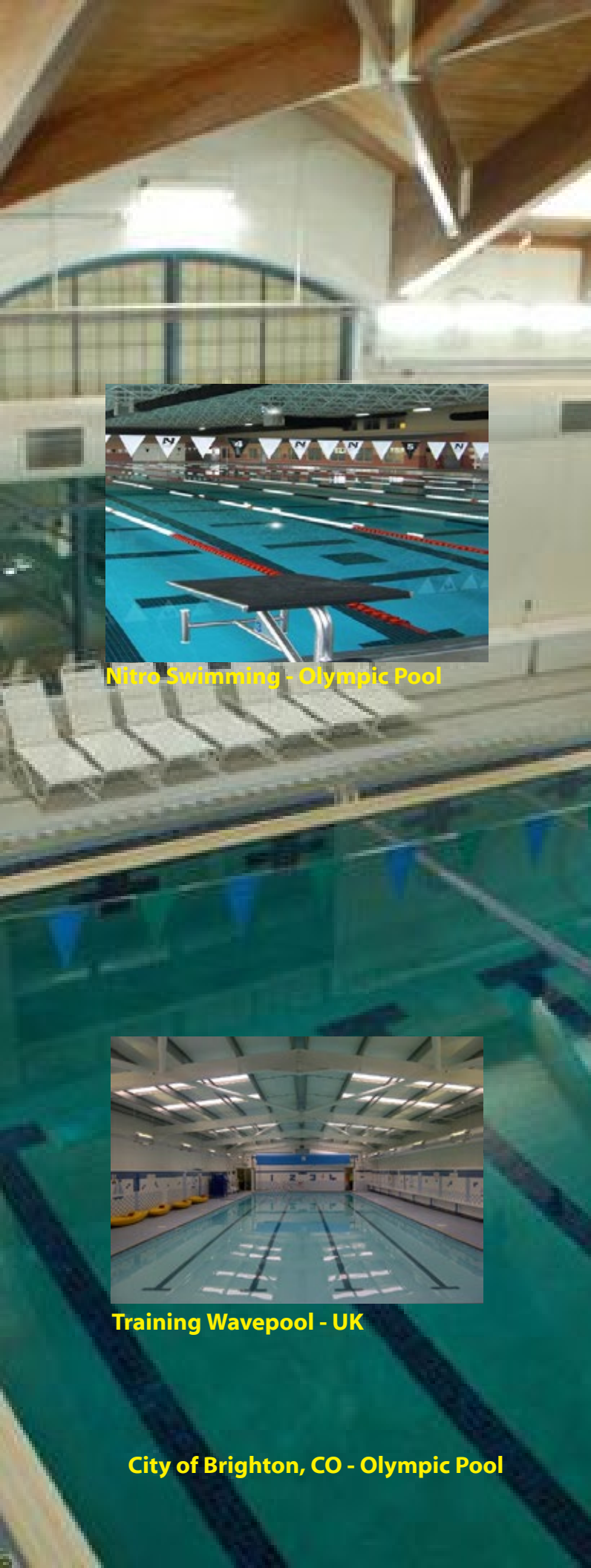

Nitro Swimming - Olympic Pool



Training Wavepool - UK

City of Brighton, CO - Olympic Pool

## Swimming Pool Lighting

Having the largest range of LED fixtures and making any mechanical brackets in-house we can react to specific requirements very quickly.

## Olympic Size Swimming Pools

ActiveLED "side throw lights" are a perfect fit with their patented reflector design that allows the highest light output to go to the furthest point and the lowest to the nearest point with a consistent increase with distance producing a perfect wash of light over the water.

Due to ActiveLED's linear light engines with a self imposed limit to light output per square inch, ActiveLED has the lowest possible glare while maintaining the highest possible light output.

ActiveLED linear side-throw light fixtures perform exceptionally well in direct pool lighting and indirect pool lighting or a mix thereof.

Water sports areas are usually plagued with moisture and a high failure rate of light fixtures. ActiveLED fixtures have found their way into shower room and rest room with a significant improvement in reliability and reduced maintenance cost.

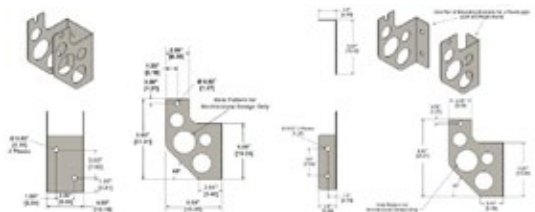

We have a number of brackets designed to fit most mounting needs as well as being able to fabricate custom mountings in our own facilities providing a turn-key kit solution, ready to be installed by an electrician.

Also Wall Pack perimeter lighting is used extensively in private and public swim sport facilities.



## Baseball and Softball

Baseball fields are significantly larger than Softball fields and have their own challenges, we have lit as big as 420 feet square areas in the most difficult conditions, from only 6 poles without any poles in the outfield.

ActiveLED has a bullet and ball proof diffuser option that allows us to have supplemental lights on the cage of the home base area, significantly reducing shadows and power required to light this critical area.

ActiveLED lighting is totally flicker free providing better recognition of fast balls at any time by eye or camera.

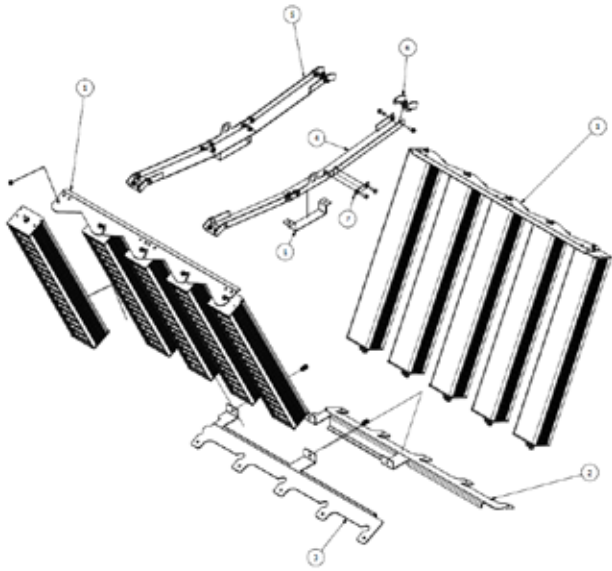

Ringdale has its own fabrication of sheet metal and produces stainless steel constructs to adapt its light fixtures to the pole structure at hand.

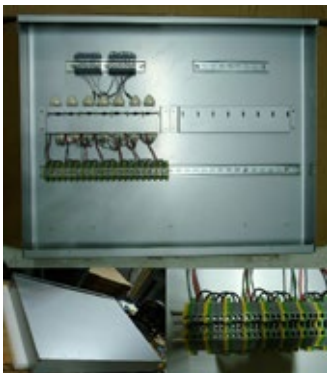

Ringdale provides junction boxes and lightning arrestors as part of the installation kit.

An advanced LightSpace® ball-field control system, capable to control either ActiveLED and/or conventional light fixtures installed on poles, remotely through a wired or wireless network.



Less Glare - More Consistent Light

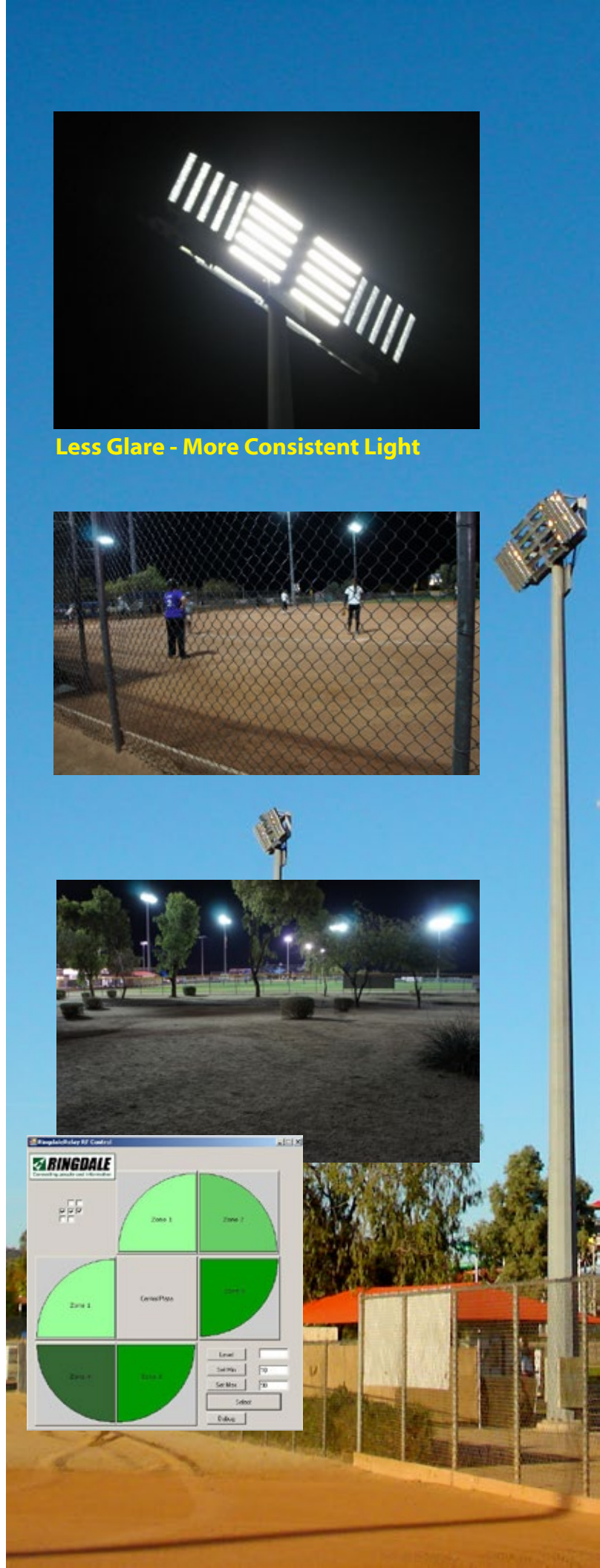
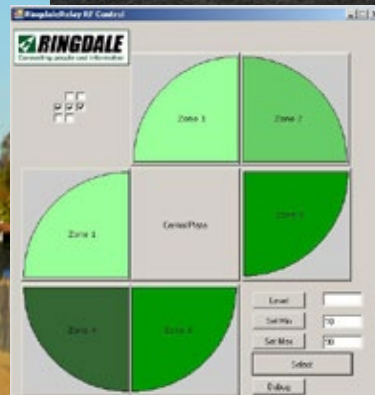



**Drill and Exercise Hall**

## Gymnasium and Drill-Hall

Multi purpose Gymnasiums and Drill Halls have been successfully converted to ActiveLED High Bay Lighting.

For schools and educational facilities, automation in form of motion sensors has been very successful in controlling light use as well as providing a secure environment.

For most indoor facilities that are air conditioned, every watt in lighting saved will save at least an additional watt in air conditioning and often 1.5 Watts.

If the air conditioning system is less taxed it also increases that system's MTTR (Mean Time To Repair).

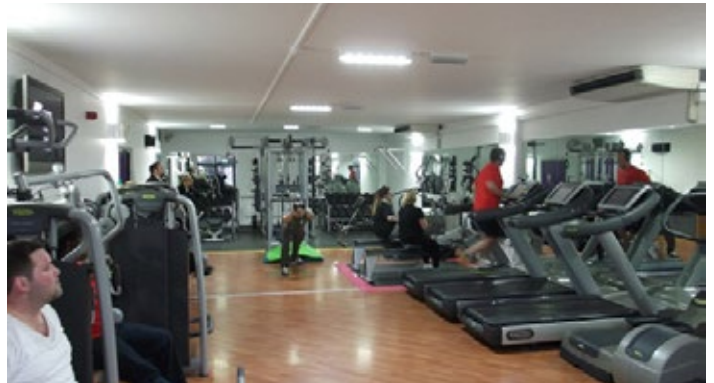

Ipswich UK - Gym

ActiveLED is well suited for lighting in Gymnasiums due to the deliberate large emitting surfaces the glare from ActiveLED light fixtures is very low.



Before

After

Ipswich UK - Multipurpose Hall

Drastic improvements could be achieved when upgrading from HPS and MH lighting to ActiveLED High Bay Lighting and controls in this UK facility.

## Basketball

### Outdoor

Depending on the available pole arrangement innovative way can be used to provide adequate lighting for a safe game or exercise.

Ringdale provides full simulation services that allow you to ascertain the effect of the light fixtures before and after the installation of ActiveLED lighting.



### Indoor Multi Purpose Sports Facility

Indoor multi-function indoor ballfields are an ideal application for ActiveLED round high bay lights or linear high bay strip lights.

Energy and maintenance savings quickly amortise the investment for most facilities where the daily use exceeds 12 hours of lighting.

An added advantage comes in hot climates without air conditioning. It has been demonstrated that the temperature could be reduced by up to 7°C when switching from conventional 400 Watt and 1000 Watt systems to ActiveLED lighting systems.



Outdoor Basketball and Exercise Field



## Ice Rink

### Indoor Ice Rinks

Indoor Ice Rinks are an ideal application for round High Bay lighting fixtures or High Bay strip lighting.

ActiveLED puck-safe light fixtures guaranteed for ten years with "no light loss" - 5 years for power electronics which can also be extended to 10 years when used with a Ringdale surge protection device.

Less power being projected on the ice surface also means less energy required to keep the ice frozen.

As Ice Rinks are generally rather cold places with an ambient temperature of 5°C ambient, the LEDs will perform with extreme efficiency due to Ringdale's patented LED Module heat sinking design.



75 Watt Round High Bay is a very economical fixture to produce adequate light output for a non-competition rink.

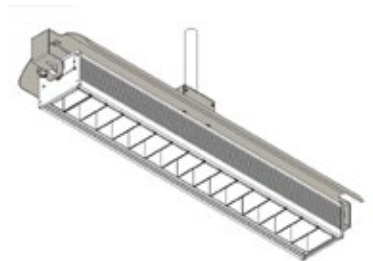

100 Watt Linear Pendant Floodlight or 150 Watt Round High Bay light fixtures are perfect for competition rinks requiring high light levels.

ActiveLED can be seamlessly dimmed using 0 to 10 Volt or EDSaP digital dimming technology as well as integrating with existing DMX systems.

## Racquetball Courts

### Retrofit

Due to our ability to make custom fixtures we have been able to adapt our 75 Watt CPYP as well as 75 Watt 2'x2' fixture to existing ball safe diffusers.

With our 10 year "no light loss" guaranty maintenance is reduced to cleaning the diffuser from time to time.

Reduced air conditioning cost is an added benefit of highly efficient ActiveLED fixtures.

The new fixtures produce more than twice the light output compared to the old 400 Watt HID's which in reality were taking ~450 Watt each.

### New Build

Ringdale can provide lighting layout as well as all frames, diffusers and lighting required for a racquetball court.

ActiveLED fixtures can be connected to ball-safe motion sensors to allow full automatic control of lights, optimizing energy use and providing safety.

Lights are programmable to go into active rest rather than turning off allowing cameras or security guards to see sufficiently if there are persons in the area, yet the lights will take a very small amount of energy in the 4..10 watt range (total together) depending on the desired minimum level.



City of Brighton, CO, Racquetball Court

## Badminton

### Indoor Badminton Courts

Another excellent application for ActiveLED linear highbay lighting are badminton courts.

We can model light conditions for your court providing an ROI that is unsurpassed by any other solution, assuming your courts are played at least 12 hours a day with lighting.

If the courts are air conditioned further savings are achieved. If the court is enclosed and not air-conditioned significantly improved comfort due to less heat emitting from the light fixtures.

A typical 10 court hall can expect an ROI of less than two years.

### LightSpace<sup>®</sup> Automation

All of the ActiveLED fixtures can be controlled using Ringdale's LightSpace Building Automation System or be interfaced inexpensively to any other building management system.

### IESNA Modelling Service

We have modelled indoor arenas, soccer fields and football fields, night playing golf courses and night skiing for ski resorts.

ActiveLED can be used in any of those applications and our 10 year no-light-loss warranty will apply.

ActiveLED light engines, power supplies, control hardware and fixtures are designed to last.



[www.ActiveLED.com](http://www.ActiveLED.com)

Call us now

USA: +1-512-288-9080

UK: +44-1444-870408

Japan: +81-3-5288-5310